

BROEN-LAB

Drejervaenget 2, 5610 Assens, Denmark

Phone: +45 6376 6376

E-mail: lab@broen-lab.com

Web : broen-lab.com

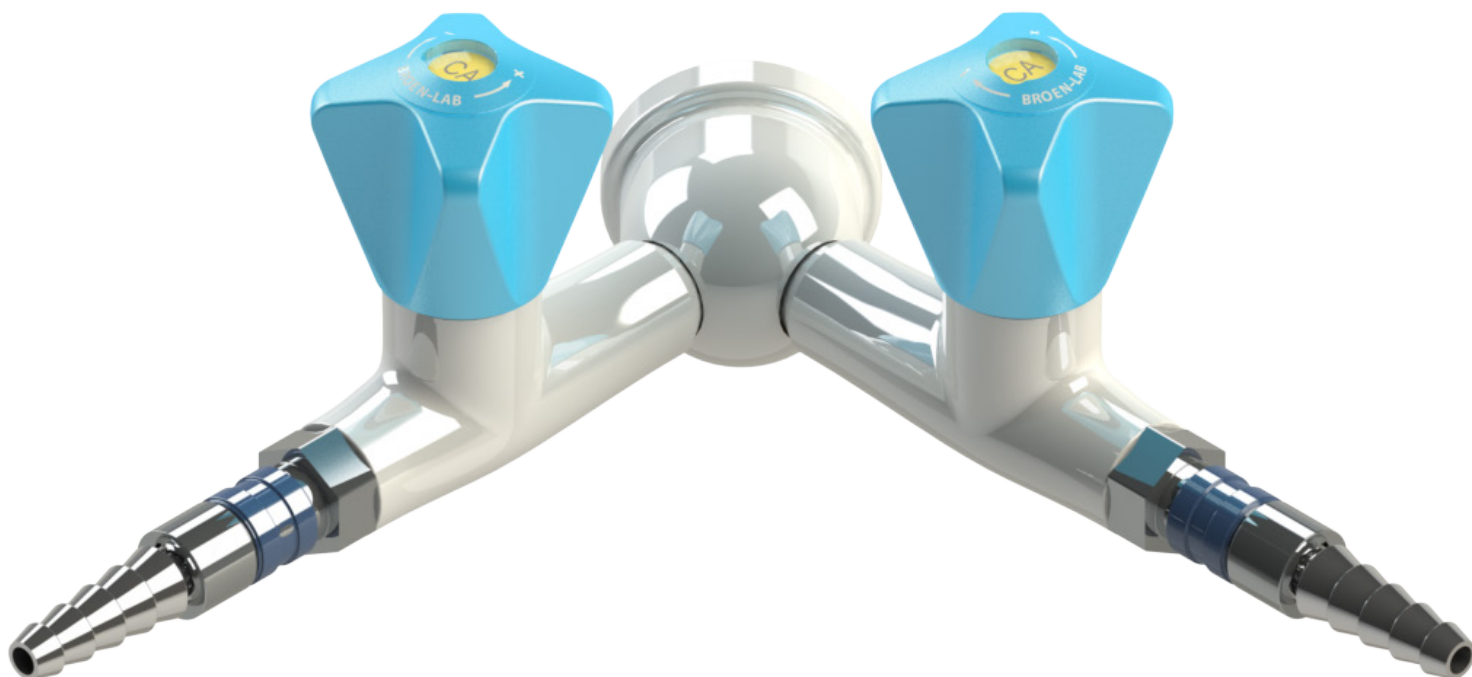









FITTINGS FOR NON-BURNING 4.0 GASES AND OXYGEN

PREMIUM range

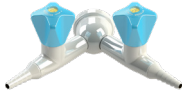
99B0063 - 05.08.2024

TABLE OF CONTENTS

BROEN-LAB UniFlex™					Page 3
Configuration overview					Page 4
Technical information					Page 5
					
Bench mounted fitting	Suspended fitting with 90° valves	Suspended fitting with 45° valves	Wall mounted double fitting with 90° valves	Wall mounted double fitting with straight valves	
Page 6	Page 7	Page 8	Page 9	Page 10	
					
Wall mounted fitting with 90° valves for exposed piping	Bench og wall mounted fitting with 90° valves and lead-in	Bench og wall mounted fitting with 45° valves and lead-in	Suspended or wall mounted staight fitting with lead-in		
Page 11	Page 12	Page 13	Page 14		
BROEN-LAB UniFlex™ hoses for technical gases					Page 16
Headworks					Page 18
Accessories					Page 20
Ordering information					Page 21

BROEN-LAB UNIFLEX™ PREMIUM

THIS IS BROEN-LAB UNIFLEX™ PREMIUM

BROEN-LAB UniFlex™ PREMIUM line offers a very high quality and durability combined with the complete program, which adds up to low LCC (Life Cycle Costs). Our PREMIUM line takes the standards in the market to a higher level.

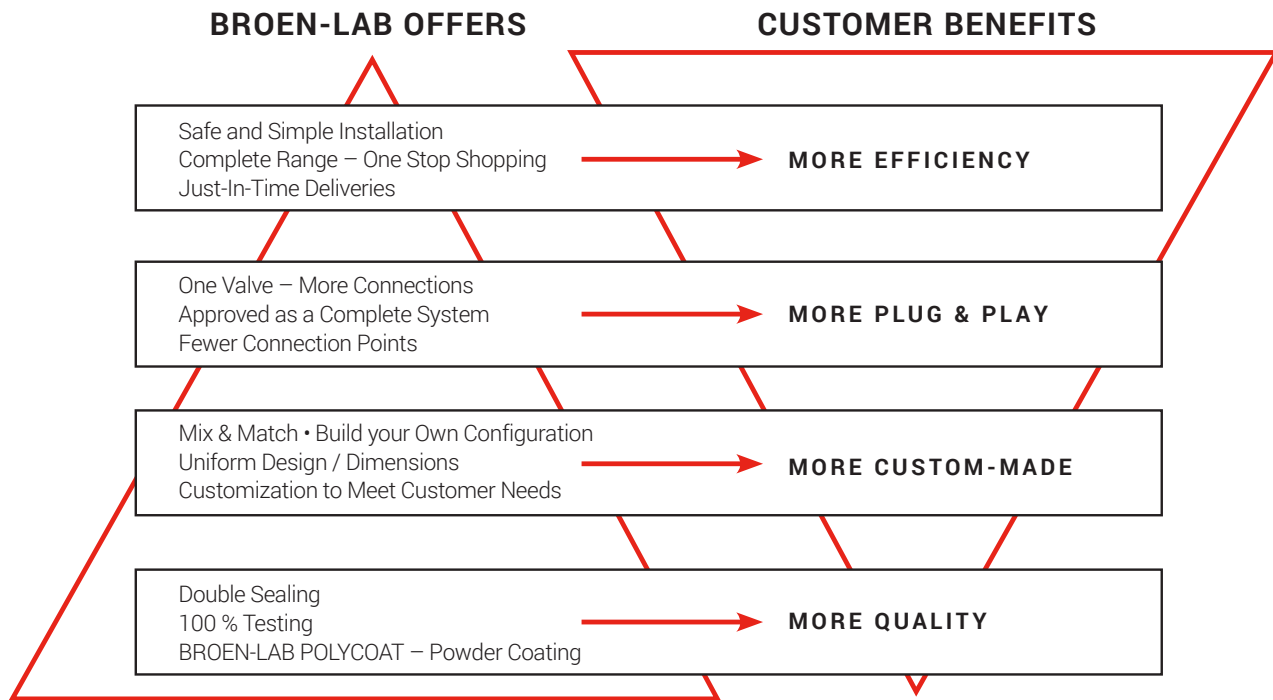

BROEN-LAB UniFlex™ PREMIUM fittings for non-burning 4.0 gases are designed for laboratory use and are adapted to Oxygen service.

The operation and the configuration of the fittings are highly adapted to the requirements of a modern laboratory. The fittings are surface treated with BROEN-LAB POLYCOAT powder coating, which is highly resistant to most chemicals, UV fading and heat (for more information please refer to "BROEN-LAB POLYCOAT" brochure).

All BROEN-LAB UniFlex™ PREMIUM fittings are delivered with a powder coated metal handle with media indication according to EN13792. As an option it is possible to get fittings with disability-friendly handle for easier operation.

BROEN-LAB UniFlex™ PREMIUM fittings for non-burning 4.0 gases / Oxygen are delivered with a fixed metal nozzle (can be removed with Allen key if needed) or a quick release coupling (hexagon coded) for easy and immediate connection and safe disconnection.

THIS IS BROEN-LAB UNIFLEX™

BROEN-LAB UniFlex™ is a unique and patented connection, which allows customers to choose from various connection methods, such as hoses, Cu, PEX or Stainless Steel pipes, without changing the valve itself. It provides unique flexibility, not only for the installer, but also for the end-user. Due to the flexibility of the system, the quick installation and savings on fittings, this system offers lower TIC (Total Installed Costs).

CONFIGURATION OVERVIEW

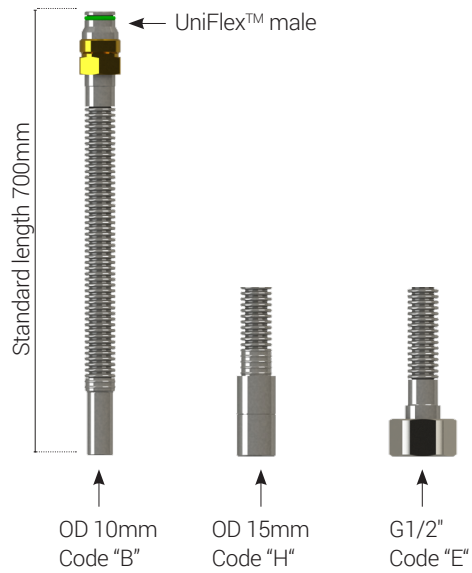
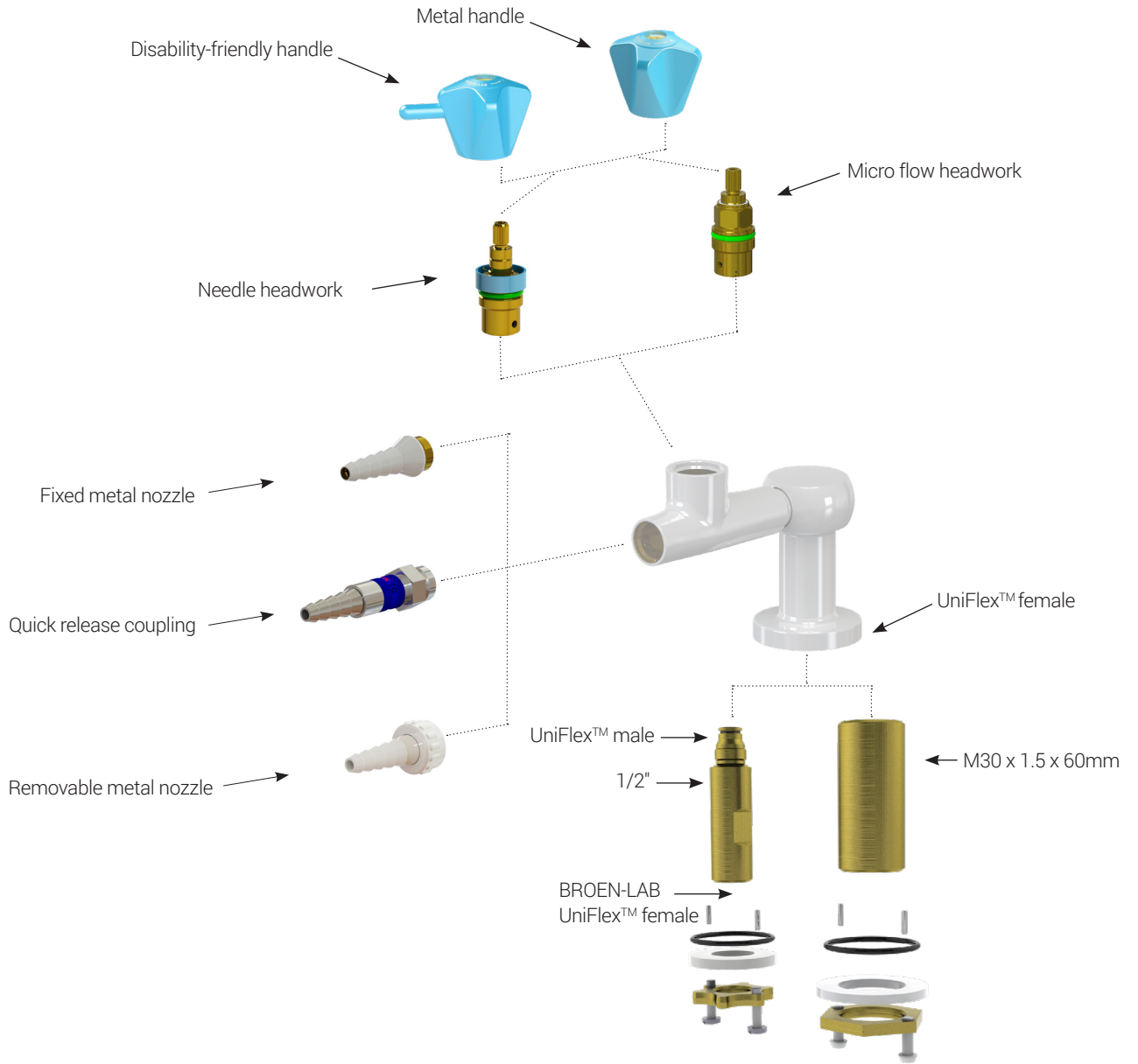

TECHNICAL INFORMATION

What is Non-burning 4.0 gas?

Non-burning 4.0 gases are typical industrial and technical gases that are 99,99% clean and should be used in applications where impurities must be avoided. Common media that require oil and grease-free fittings are Oxygen, Instrumental, Synthetic and Medical air as well as Helium and other oil-free gases for use with critical instrumentation.

BROEN-LAB UniFlex™ fittings for non-burning 4.0 gases are adapted to Oxygen service, meaning that the presence of mineral based oils and grease is minimized. Materials with media contact are Oxygen approved and ultrasonically cleaned. Assembled fittings are individually packed into sealed plastic bags.

What is oxygen?

Oxygen is the most abundant element on the earth's surface. In its most well-known form it constitutes 21% of the atmosphere, it is a tasteless, odorless and colorless gas essential to life.

Oxygen itself is not the fuel, but the oxidant and can ignite or support a fire if it comes into contact with flammable substances.

Oxygen is used in innumerable application in industries such as:

- chemicals
- pharmaceuticals
- healthcare
- laboratory and analysis
- food and beverage
- electronics, etc.

System requirements

Due to the physical and chemical properties of Oxygen the following requirements are set up to an Oxygen system:

- valves and fittings that should be applied with Oxygen must be free of mineral based oil and grease
- materials that come into contact with Oxygen (metals, O-rings, gaskets, plastics, lubricants, etc.) must be Oxygen approved
- recommended working pressure for Oxygen must not be exceeded
- valves must be opened slowly in order to avoid possible ignition.

Our headworks

BROEN-LAB UniFlex™ fittings for non-burning 4.0 gases can be delivered with 2 different types of headworks depending on the requirements set by applications with regards to regulation of media flow.

Needle headwork

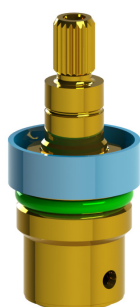

Micro flow headwork

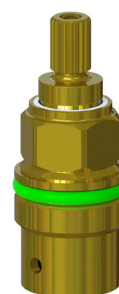

As a standard all BROEN-LAB UniFlex™ fittings for non-burning 4.0 gases are delivered with a needle headwork that allows fine regulation of media flow and the valve is fully opened after 3 x 360° rotations of a handle.

In cases where media flow is close to zero and when a microscopic flow rate is required then it is an option to choose a micro flow headwork, which provides a very fine regulation of media flow.

For more information about BROEN-LAB headworks and technical details please refer to page 18 in this catalogue.

BENCH MOUNTED FITTING

Specifications

Handle: Metal, BROEN-LAB POLYCOAT powder coated with media indication according to EN13792
 Hose nozzle: Metal, fixed (can be unscrewed with Allen key, thread: male G3/8")
 Headwork: Needle
 Opening/closing function: 3 x 360°
 Max. working pressure:
 16 bar / 232 psi
 Allowable test pressure after installation:
 1.5 x max working pressure without function of the valve

Materials with media contact

Materials with media contact are Oxygen approved and ultrasonically cleaned.

Metals: Brass
 Plastics: PVDF
 Sealing: FKM
 Lubricant: Perfluoropolyether based

Ordering information

For standard configuration please refer to the item numbers below.

Other options:

- different media
- removable hose nozzle with union nut
- disability-friendly handle (single valve only)
- micro flow headwork
- alternative hose inlet connection / without a hose
- other inlet options (type, length)

With fixed nozzle

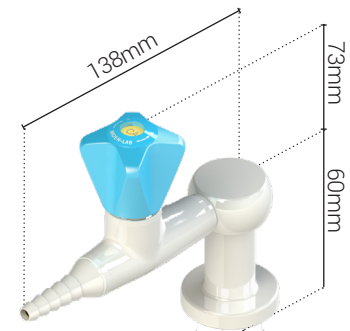



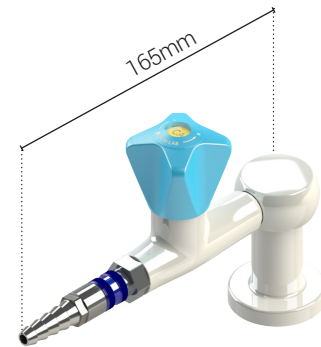

With quick release coupling



Configuration options

4.0 Gases: Choose outlet connection, number of valves and media type:

	 1-way valve	 2-way 90° valve	 2-way 180° valve	 4-way valve
Fixed nozzle	2532 040 10 XX-YY	2532 042 10 XX-YY	2532 041 10 XX-YY	2532 044 10 XX-YY
Quick release nozzle	2532 099 10 XX-YY	2532 100 10 XX-YY	2532 101 10 XX-YY	2532 102 10 XX-YY

Replace **XX** with one of these media types:

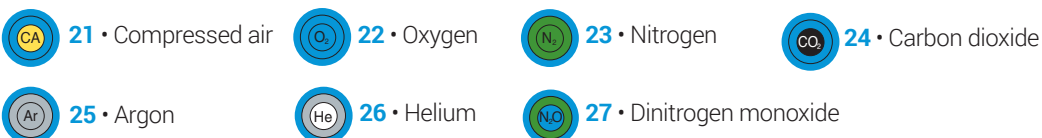

Replace with the inlet type you need on page 21

SUSPENDED FITTING WITH 90° VALVES

Specifications

Handle: Metal, BROEN-LAB POLYCOAT powder coated with media indication according to EN13792
 Hose nozzle: Metal, fixed (can be unscrewed with Allen key, thread: male G3/8")
 Headwork: Needle
 Opening/closing function: 3 x 360°
 Max. working pressure:
 16 bar / 232 psi
 Allowable test pressure after installation:
 1.5 x max working pressure without function of the valve

Materials with media contact

Materials with media contact are Oxygen approved and ultrasonically cleaned.

Metals: Brass
 Plastics: PVDF
 Sealing: FKM
 Lubricant: Perfluoropolyether based

Ordering information

For standard configuration please refer to the item numbers below.

Other options:

- different media
- removable hose nozzle with union nut
- micro flow headwork
- alternative hose inlet connection / without a hose
- other inlet options (type, length)

With fixed nozzle

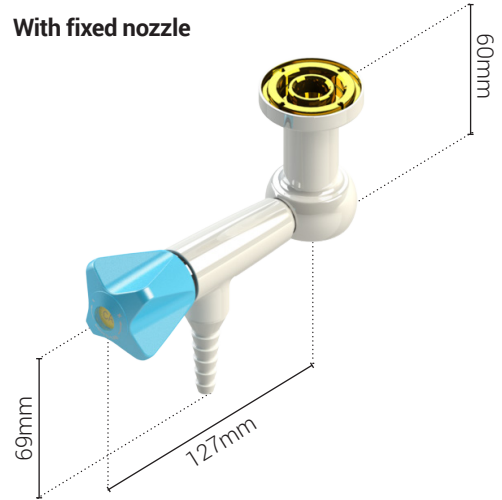

With quick release coupling

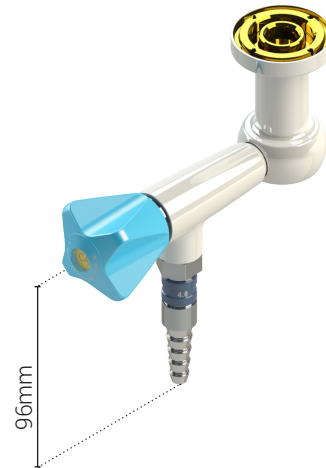

Configuration options

4.0 Gases: Choose outlet connection, number of valves and media type:



	1-way valve	2-way 90° valve	2-way 180° valve	4-way valve
Fixed nozzle	2530 123 10XX - YY	2530 151 10XX - YY	2530 055 10XX - YY	2530 152 10XX - YY
Quick release nozzle	2530 153 10XX - YY	2530 154 10XX - YY	2530 155 10XX - YY	2530 156 10XX - YY

Replace **XX** with one of these media types:



21 • Compressed air



22 • Oxygen



23 • Nitrogen



24 • Carbon dioxide



25 • Argon



26 • Helium



27 • Dinitrogen monoxide

Replace with the inlet type you need on page 21

SUSPENDED FITTING WITH 45° VALVES

Specifications

Handle: Metal, BROEN-LAB POLYCOAT powder coated with media indication according to EN13792
 Hose nozzle: Metal, fixed (can be unscrewed with Allen key, thread: male G3/8")
 Headwork: Needle
 Opening/closing function: 3 x 360°
 Max. working pressure:
 16 bar / 232 psi
 Allowable test pressure after installation:
 1.5 x max working pressure without function of the valve

Materials with media contact

Materials with media contact are Oxygen approved and ultrasonically cleaned.

Metals: Brass
 Plastics: PVDF
 Sealing: FKM
 Lubricant: Perfluoropolyether based

Ordering information

For standard configuration please refer to the itemnumbers below.

Other options:

- different media
- removable hose nozzle with union nut
- micro flow headwork
- alternative hose inlet connection / without a hose
- other inlet options (type, length)

With fixed nozzle

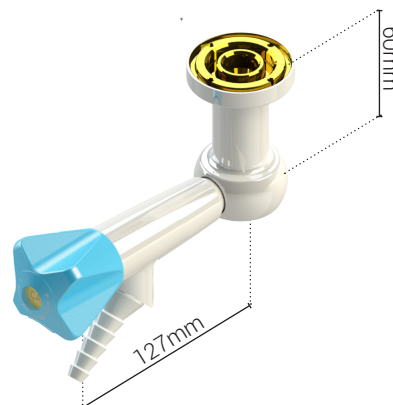

With quick release coupling

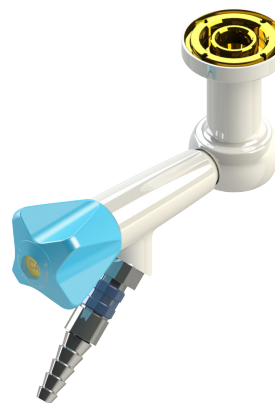

Configuration options

4.0 Gases: Choose outlet connection, number of valves and media type:



	1-way valve	2-way 90° valve	2-way 180° valve	4-way valve
Fixed nozzle	2530 157 10XX - YY	2530 158 10XX - YY	2530 063 10XX - YY	2530 159 10XX - YY
Quick release nozzle	2530 160 10XX - YY	2530 161 10XX - YY	2530 162 10XX - YY	2530 163 10XX - YY

Replace **XX** with one of these media types:



• Compressed air



• Oxygen



• Nitrogen



• Carbon dioxide



• Argon



• Helium



• Dinitrogen monoxide

Replace **YY** with the inlet type you need on page 21

WALL MOUNTED DOUBLE FITTING WITH 90° VALVES

Specifications

Handle: Metal, BROEN-LAB POLYCOAT powder coated with media indication according to EN13792
 Hose nozzle: Metal, fixed (can be unscrewed with Allen key, thread: male G3/8")
 Headwork: Needle
 Opening/closing function: 3 x 360°
 Max. working pressure:
 16 bar / 232 psi
 Allowable test pressure after installation:
 1.5 x max working pressure without function of the valve

Materials with media contact

Materials with media contact are Oxygen approved and ultrasonically cleaned.

Metals: Brass
 Plastics: PVDF
 Sealing: FKM
 Lubricant: Perfluoropolyether based

Ordering information

For standard configuration please refer to the item numbers below.

Other options:

- different media
- removable hose nozzle with union nut
- disability-friendly handle
- micro flow headwork
- alternative hose inlet connection / without a hose
- other inlet options (type, length)

With fixed nozzle

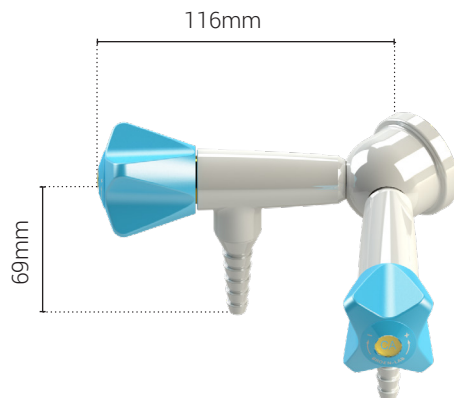

With quick release coupling

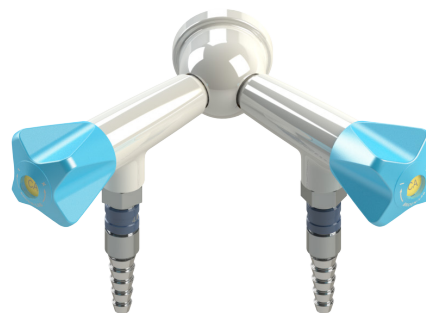

Configuration options

4.0 Gases: Choose outlet connection and media type:

	2-way 90° valve
Fixed nozzle	2530 164 10XX - YY
Quick release nozzle	2530 165 10XX - YY

Replace with one of these media types:



21 • Compressed air



• Oxygen



• Nitrogen



24 • Carbon dioxide



• Argon



26 • Helium



• Dinitrogen monoxide

Replace with the inlet type you need on page 21

WALL MOUNTED DOUBLE FITTING WITH STRAIGHT VALVES

Specifications

Handle: Metal, BROEN-LAB POLYCOAT powder coated with media indication according to EN13792
 Hose nozzle: Metal, fixed (can be unscrewed with Allen key, thread: male G3/8")
 Headwork: Needle
 Opening/closing function: 3 x 360°
 Max. working pressure:
 16 bar / 232 psi
 Allowable test pressure after installation:
 1.5 x max working pressure without function of the valve

Materials with media contact

Materials with media contact are Oxygen approved and ultrasonically cleaned.

Metals: Brass
 Plastics: PVDF
 Sealing: FKM
 Lubricant: Perfluoropolyether based

Ordering information

For standard configuration please refer to the item numbers below.

- Other options:
- different media
 - removable hose nozzle with union nut
 - micro flow headwork
 - alternative hose inlet connection / without a hose
 - other inlet options (type, length)

With fixed nozzle

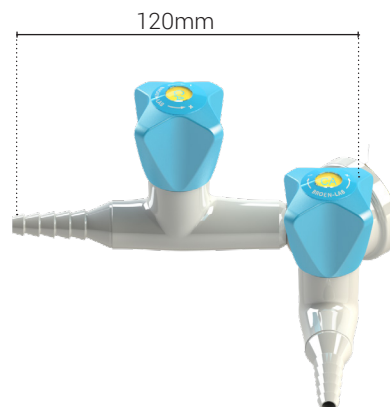

With quick release coupling

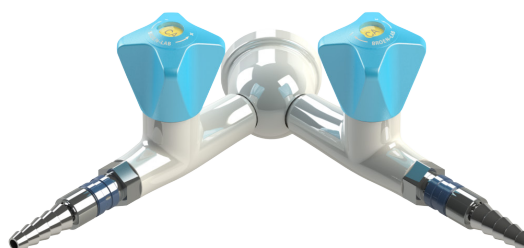

Configuration options

4.0 Gases: Choose outlet connection and media type:

	2-way 90° valve
Fixed nozzle	2532 089 10XX - YY
Quick release nozzle	2532 103 10XX - YY

Replace with one of these media types:

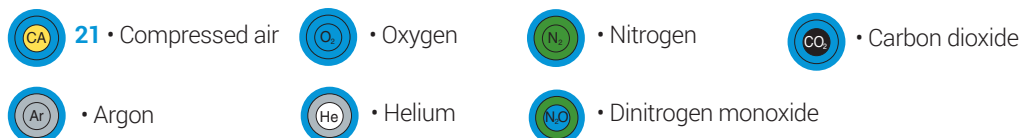

Replace with the inlet type you need on page 21

WALL MOUNTED FITTING WITH 90° VALVES FOR EXPOSED PIPING

Specifications

Handle: Metal, BROEN-LAB POLYCOAT powder coated with media indication according to EN13792
 Hose nozzle: Metal, fixed (can be unscrewed with Allen key, thread: male G3/8")
 Headwork: Needle
 Opening/closing function: 3 x 360°
 Max. working pressure: 16 bar / 232 psi
 Allowable test pressure after installation: 1.5 x max working pressure without function of the valve

Materials with media contact

Materials with media contact are Oxygen approved and ultrasonically cleaned.

Metals: Brass
 Plastics: PVDF
 Sealing: FKM
 Lubricant: Perfluoropolyether based

Ordering information

For standard configuration please refer to the item numbers below.

Other options:

- different media
- removable hose nozzle with union nut
- disability-friendly handle
- micro flow headwork
- alternative hose inlet connection / without a hose
- other inlet options (type, length)
- model with straight valve

With fixed nozzle

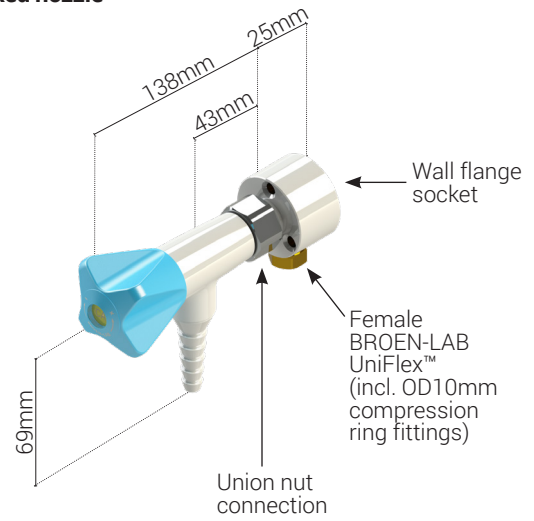

With quick release coupling

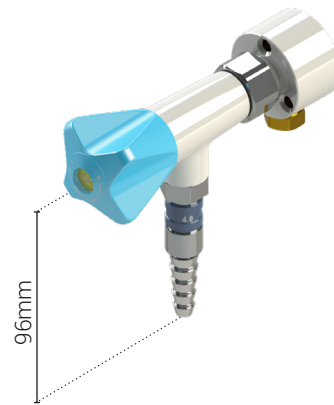

Configuration options

4.0 Gases: Choose outlet connection and media type:

	1-way valve
Fixed nozzle	2530 068 10XX - T
Quick release nozzle	2530 166 10XX - T

Replace with one of these media types:



21 • Compressed air



• Oxygen



• Nitrogen



24 • Carbon dioxide



• Argon



• Helium



• Dinitrogen monoxide

BENCH OR WALL MOUNTED 90° FITTING WITH LEAD-IN

Specifications

Handle: Metal, BROEN-LAB POLYCOAT powder coated with media indication according to EN13792

Hose nozzle: Metal, fixed (can be unscrewed with Allen key, thread: male G3/8")

Headwork: Needle

Opening/closing function: 3 x 360°

Max. working pressure:

16 bar / 232 psi

Allowable test pressure after installation:

1.5 x max working pressure without function of the valve

Materials with media contact

Materials with media contact are Oxygen approved and ultrasonically cleaned.

Metals:	Brass
Plastics:	PVDF
Sealing:	FKM
Lubricant:	Perfluoropolyether based

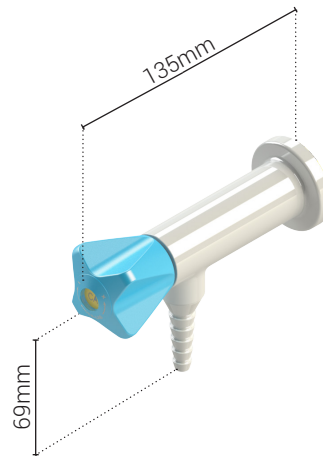

Ordering information

For standard configuration please refer to the item numbers below.

Other options:

- different media
- removable hose nozzle with union nut
- micro flow headwork
- alternative hose inlet connection / without a hose
- other inlet options (type, length)

Configuration options

4.0 Gases: Choose outlet connection and media type:

	1-way valve
Fixed nozzle	2530 329 10 XX - YY
Quick release nozzle	2530 330 10 XX - YY

Replace **XX** with one of these media types:



• Compressed air



22 • Oxygen



23 • Nitrogen



• Carbon dioxide



25 • Argon



26 • Helium



• Dinitrogen monoxide

Replace **YY** with the inlet type you need on page 21

BENCH OR WALL MOUNTED 45° FITTING WITH LEAD-IN

Specifications

Handle: Metal, BROEN-LAB POLYCOAT powder coated
 with media indication according to EN13792
 Hose nozzle: Metal, fixed (can be unscrewed with Allen key, thread: male G3/8")
 Headwork: Needle
 Opening/closing function: 3 x 360°
 Max. working pressure:
 16 bar / 232 psi
 Allowable test pressure after installation:
 1.5 x max working pressure without function of the valve

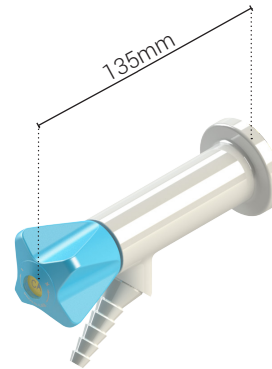

Materials with media contact

Materials with media contact are Oxygen approved and ultrasonically cleaned.

Metals: Brass
 Plastics: PVDF
 Sealing: FKM
 Lubricant: Perfluoropolyether based

Ordering information

For standard configuration please refer to the item numbers below.

Other options:

- different media
- removable hose nozzle with union nut
- micro flow headwork
- alternative hose inlet connection / without a hose
- other inlet options (type, length)

Configuration options

4.0 Gases: Choose outlet connection and media type:

	1-way valve
Fixed nozzle	2530 347 10XX - YY
Quick release nozzle	2530 348 10XX - YY

Replace with one of these media types:

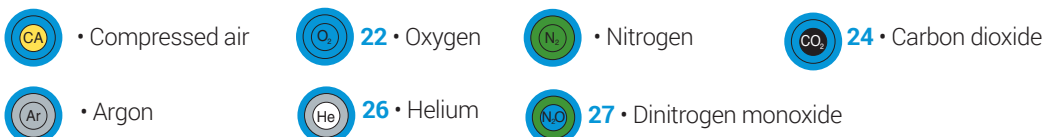

Replace with the inlet type you need on page 21

SUSPENDED OR WALL MOUNTED STRAIGHT FITTING WITH LEAD-IN

Specifications

Handle: Metal, BROEN-LAB POLYCOAT powder coated with media indication according to EN13792
 Hose nozzle: Metal, fixed (can be unscrewed with Allen key, thread: male G3/8")
 Headwork: Needle
 Opening/closing function: 3 x 360°
 Max. working pressure:
 16 bar / 232 psi
 Allowable test pressure after installation:
 1.5 x max working pressure without function of the valve

Materials with media contact

Materials with media contact are Oxygen approved and ultrasonically cleaned.

Metals: Brass
 Sealing: FKM
 Lubricant: Perfluoropolyether based

Ordering information

For standard configuration please refer to the item numbers below.

Other options:

- different media
- removable hose nozzle with union nut
- micro flow headwork
- alternative hose inlet connection / without a hose
- other inlet options (type, length)



Configuration options

4.0 Gases: Choose outlet connection and media type:

	1-way valve
Fixed nozzle	2532 167 10XX - YY
Quick release nozzle	2532 169 10XX - YY

Replace **XX** with one of these media types:



• Compressed air



22 • Oxygen



• Nitrogen



24 • Carbon dioxide



25 • Argon



26 • Helium



27 • Dinitrogen monoxide

Replace **YY** with the inlet type you need on page 21

BROEN-LAB UNIFLEX™ PIPES AND HOSES FOR NON-BURNING 4.0 GASES AND VACUUM

BROEN-LAB UniFlex™ flexible pipes and hoses

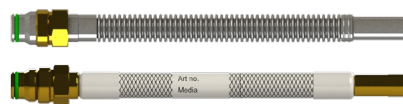

BROEN-LAB LAB offers BROEN-LAB UniFlex™ pipes and hoses as an easy way to make the installation in the laboratory where safety and efficiency are required. BROEN-LAB UniFlex™ pipes and hoses are the ideal solution where there is a higher requirement for flexibility. Installation with flexible hoses saves you time and labor - in other words reduced installation costs.

BROEN-LAB UniFlex™ pipes and hoses for non-burning 4.0 gases and vacuum are manufactured of corrugated Stainless Steel or PTFE with a Stainless Steel braiding that ensures long service life and durability.

A wide range of fittings and lengths is available for BROEN-LAB UniFlex™ hoses enables customers to choose the perfect hose for their application. Please request document No. 99G0005 for complete range of BROEN-LAB UniFlex™ hoses and technical specifications.

If you still prefer a standard way of installation with Cu, Stainless Steel, or PEX-pipes, BROEN-LAB LAB offers a wide range of connection fittings and adaptors for pipes of different dimensions. Please request document No. 99G0004 for a complete range of BROEN-LAB UniFlex™ compression ring fittings.

BROEN-LAB UniFlex™ connection fittings and adaptors for CU, Stainless Steel and PEX pipes

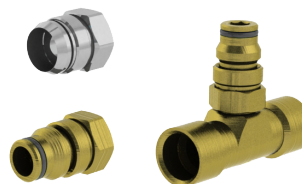

The total design of the system must be taken into consideration when selecting the type of BROEN-LAB UniFlex™ flexible hose or pipe for specific media. Only then products will provide safe, trouble-free operation.

Please always check local requirements/regulations regarding installation and maintenance of hoses/flexible pipes!









A very high quality of materials applied for production of hoses and Stainless Steel flexible pipes, which are supplied by BROEN-LAB, and a long-time experience in making installations worldwide, combined with optimal installation conditions, may assure a lifetime for a hose to be more than 10 years. Expected lifetime can only be achieved under normal use and proper installation methods, which are described in technical specifications, i.e. max. working pressure, max. temperature, physical installation methods and other. Any nonconformity to specifications decreases the lifetime of a hose/flexible pipe.

Factors*	Hose	SS	PTFE
		93Q	93R
Inner hose material with media contact		Corrugated Stainless Steel AISI 316	PTFE**
Outer hose material / braiding		None	Stainless Steel AISI 304
Sealing material		FKM	FKM
Inside diameter		8.5 mm	6.3 mm
Outside diameter		12 mm	9.5 mm
Max. working pressure		21 bar	21 bar
Max. working temperature		50°C	50°C
Min. bending radius (inner)		15 mm (Single bend) 130 mm (Dynamic bend)	60 mm
Leakage rate		<1x10 ⁻⁷ mbar l/s [He] (93Q)	**
UV resistance		+++	++
Range of connections		++	+++

** PTFE and rubber are penetrable materials meaning that gases, vapors, and liquids may diffuse through them. Therefore, for applications where a defined gas content is required, or absorbed gases might disturb applications, alternative materials could be considered. Check compatibility with gases in application!

93Q - BROEN-LAB UNIFLEX™ FLEXIBLE STAINLESS STEEL PIPES FOR OXYGEN AND HIGH PURITY GASES UP TO 5.0

INLET CONNECTIONS 93 Q **XX** XX XXXX

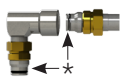
10	OD10 mm connection for compression fittings	
12	OD12 mm connection for compression fittings	
15	OD15 mm connection for compression	
09	OD3/8" connection for compression fittings	
20	Straight BROEN-LAB UniFlex™ connection with FKM O-ring	
34	3/8" NPT fixed male connection	
70	1/4" NPT fixed male connection	
41	Female G3/8" union nut connection	
40	Female G1/2" union nut connection	
30	90° BROEN-LAB UniFlex™ connection with FKM O-ring	

OUTLET CONNECTIONS 93 Q XX **XX** XXXX

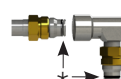
20	Straight BROEN-LAB UniFlex™ connection with FKM O-ring	
30	90° BROEN-LAB UniFlex™ connection with FKM O-ring	

*All O-rings are lubricated with perfluoropolyether based lubricant

LENGTH 93 Q XX XX **XXXX**

Stainless steel 1.4404 flexible pipe

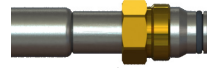

Marking for clean gas with Part no.

HOSE LENGTHS

Definition of length (L)

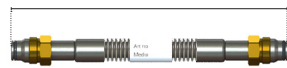

**Standard lengths of hoses (L):

- 0500** = 500 mm
- 0700** = 700 mm
- 1000** = 1000 mm
- 1200** = 1200 mm
- 1500** = 1500 mm
- 2000** = 2000 mm
- 2500** = 2500 mm
- 3000** = 3000 mm

Length tolerance of hoses:
 L = ≤400 mm (- 0, +10 mm)
 L = 401 mm to 1000 mm (- 0, + 20 mm)
 L = >1000 mm (- 0, + 30 mm)

** Other lengths are available on request

SPECIFICATIONS

Inner hose material: Corrugated*** Stainless Steel 1.4404 similar to AISI 316L (acc. to EN 10028-7). Cleaned for use with gases having purity coefficient 6.0 (99,9999% pure gases)
 Braiding: None
 Materials with media contact: Stainless Steel 1.4404, FKM (Viton) with Perfluoropolyether based lubricant
 Inside diameter: 8.5 mm
 Outside diameter: 12 mm
 Max. working pressure: 21bar
 Max. working temperature: 50°C
 Bending radius (inner):

- ≥ 15 mm (static)
- ≥ 130 mm (dynamic)

Min. length with connections: 500 mm
 Max. movements (Bending radius 130 mm): 10.000**
 Leakage rate: <1x10⁻⁷ mbar l/s [He]

** In accordance with ISO 10380

EXAMPLE OF HOSE CONFIGURATION

1200 mm hose with OD 12 mm inlet connection and straight UniFlex™ outlet connection



93Q12201200

*** Corrugated hoses have a large inner surface with media contact, therefore extended flushing may be required before taking into use! BROEN-LAB recommends purging by pressurizing a system by 10 bar to be repeated for 5-7 times.

93R - BROEN-LAB UNIFLEX™ HOSES FOR OXYGEN AND HIGH PURITY GASES UP TO 5.0

INLET CONNECTIONS 93 R XX XX XXXX

41	Female G3/8" union nut connection	
40	Female G1/2" union nut connection	
10	OD10 mm connection for compression fittings	
12	OD12 mm connection for compression fittings	
15	OD15 mm connection for compression fittings	
20	Straight BROEN-LAB UniFlex™ connection with FKM O-ring	
25	45° BROEN-LAB UniFlex™ connection with FKM O-ring	
30	90° BROEN-LAB UniFlex™ connection with FKM O-ring	

OUTLET CONNECTIONS 93 R XX XX XXXX

20	Straight BROEN-LAB UniFlex™ connection with FKM O-ring	
25	45° BROEN-LAB UniFlex™ connection with FKM O-ring	
30	90° BROEN-LAB UniFlex™ connection with FKM O-ring	

*All O-rings are lubricated with perfluoropolyether based lubricant

LENGTH 93 R XX XX XXXX

PTFE hose with braiding in Stainless Steel

Marking for clean gas with Part no. and Media indication

HOSE LENGTHS

Definition of length (L)

Definition of length (L)

If 45° and 90° elbows occur on the same hose, it will as default be mounted in U-form

**Standard lengths of hoses (L):

- 0500** = 500 mm
- 0700** = 700 mm
- 1000** = 1000 mm
- 1200** = 1200 mm
- 1500** = 1500 mm
- 2000** = 2000 mm
- 2500** = 2500 mm
- 3000** = 3000 mm

Length tolerance of hoses:
 L = ≤400 mm (- 0, +10 mm)
 L = 401 mm to 1000 mm (- 0, + 20 mm)
 L = >1000 mm (- 0, + 30 mm)

** Other lengths are available on request

SPECIFICATIONS

Inner hose material: PTFE***
 Braiding: Stainless Steel
 Materials with media contact: PTFE, Brass, FKM*** with perfluoropolyether based lubricant (Oxygen approved)
 Inside diameter: 6.3 mm
 Outside diameter: 9.5 mm
 Max. working pressure: 21 bar
 Max. working temperature: 50°C
 Bending radius (inner): ≥ 60 mm
 Min. length with connections: 160 mm
 Packaging: individually packed in sealed bags

*** PTFE and FKM are penetrable materials meaning that gases, vapors, and liquids may diffuse through them. Therefore, for applications where a defined gas content is required, or absorbed gases might disturb applications, alternative materials could be considered i.e.

- 93Q Flexible Stainless Steel pipe on page 16
- 93S Flexible Stainless Steel pipe on page 17

Check compatibility with gases in application!

EXAMPLE OF HOSE CONFIGURATION

1200 mm hose with OD 12 mm inlet connection and straight UniFlex™ outlet connection



93R12201200

TECHNICAL INFORMATION

NEEDLE HEADWORK

Specifications

BROEN-LAB UniFlex™ fittings for non-burning 4.0 gases / Oxygen are as a standard delivered with needle headwork for fine regulation of media flow.

Opening/closing function: 3 x 360° turn

Media: Non-burning 4.0 (99.99% clean) gases / Oxygen

Max. working pressure: 16 bar / 232 psi

Test pressure: 1.5 x max. working pressure without function of the valve

Materials with media contact

Metals: Brass

Plastics: PVDF

Sealing: FKM

Lubricant: Perfluoropolyether based

Ordering information

1. Blue plastic ring • No. 0255 035-6308

2. Needle headwork • Not available as a spare part (for safety reasons)

Flow Chart

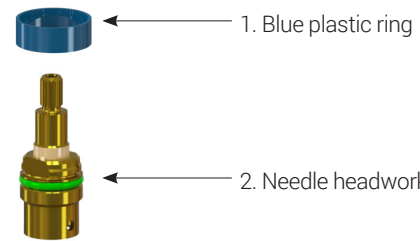
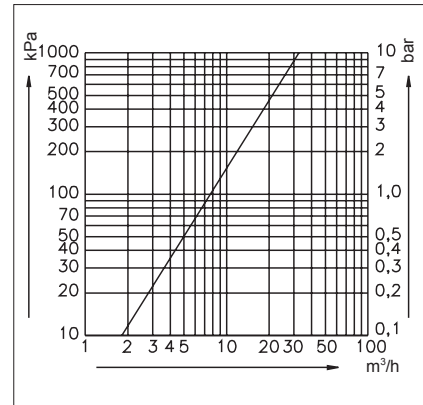

TECHNICAL INFORMATION

HIGH FLOW HEADWORK

Specifications

BROEN-LAB Micro flow headwork ensures very fine regulation of media where flow of gas is close to zero and microscopic flow rates are required.

Opening/closing function: 7.5 x 360° turn

Media: Non-burning 4.0 (99.99% clean) gases / Oxygen

Working pressure: 16 bar / 232 psi

Test pressure: 1.5 x working pressure

Materials with media contact

Metals: Brass

Plastics: PVDF

Sealing: FKM

Lubricant: Perfluoropolyether based

Ordering information

Not available as a spare part (for safety reasons).

Flow Chart

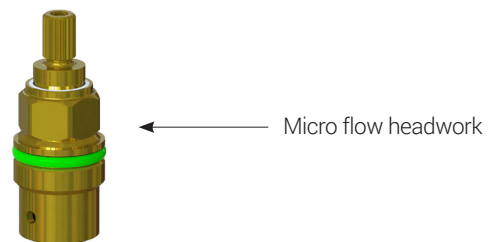
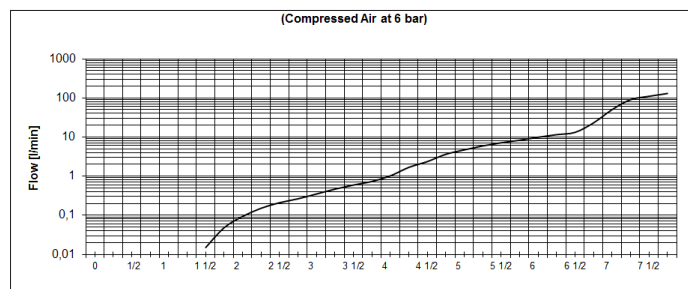

ACCESSORIES

	Adaptor for removable nozzle 3/8 to G1/2"	2539 043 1021	
	Removable metal nozzle G1/2"	2539 008 1021	
	Fixed metal nozzle 3/8	2539 042 1021	
	Quick release coupling (hexagon coded) Coupling unit Nozzle unit	96C0043 96C0040	
	Mounting set for G1/2" connection Mounting set for M30x1.5 connection	19 141 000 19 190 000	
	G1/2" inlet with female BROEN-LAB UniFlex™ connection (incl. o-ring) L = 30mm L = 60mm L = 90mm	15 504 330 15 504 120 15 504 460	Code - Code - Code -
	Threaded inlet pipe M30x1.5 L = 30mm L = 60mm L = 90mm	19 190 03 19 190 02 19 190 04	Code - Code - Code -
	Wall flange socket (WFS) (for exposed piping)	02 101 309G	
	Wall flange socket (WFS) (for built-in installation) Recommended visible length 16mm 74mm 25mm Female BROEN-LAB UniFlex™	02 101 31G	
	Cover flange for wall flange socket (WFS) Ø62.5mm	14 923 049G	
	Metal handle with media indication according to EN 13792	19 160 149 10 19 160 149 10 Replace with the media on page 23	

ORDERING INFORMATION



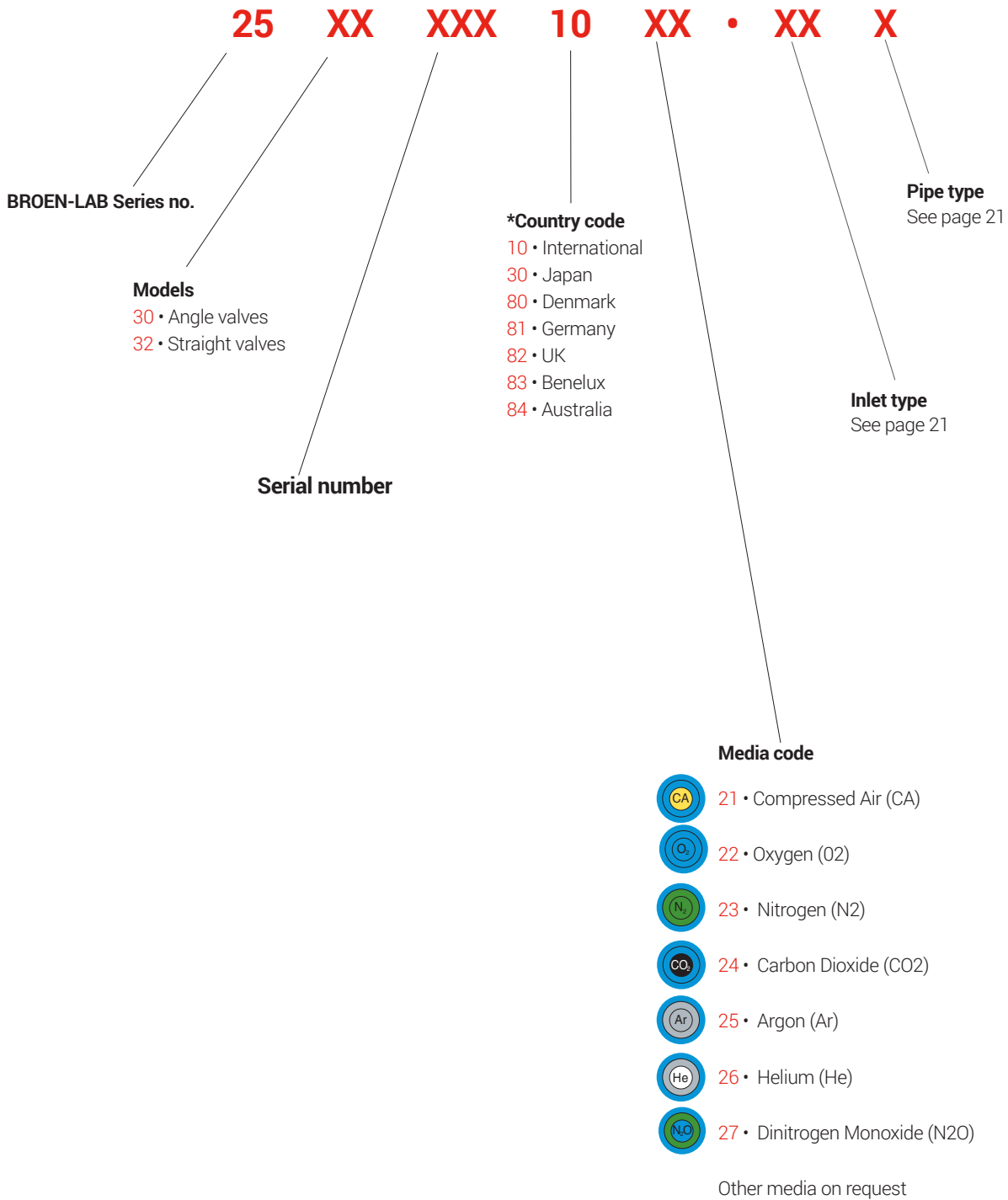

Generally, item number for BROEN-LAB UniFlex™ fittings has the following structure:

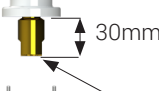
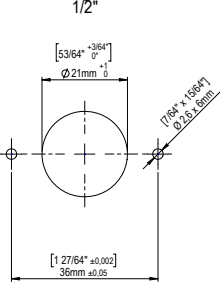
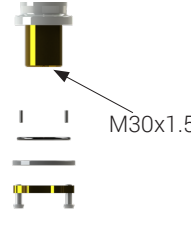
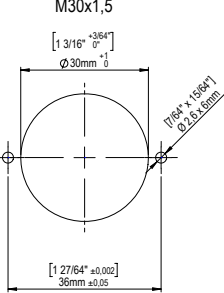
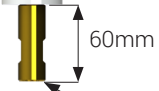
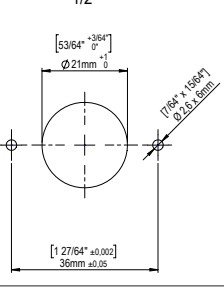
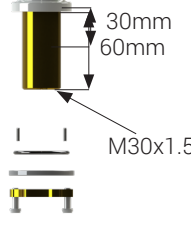
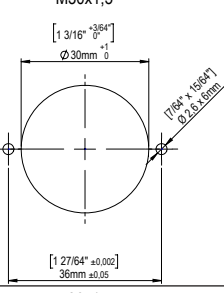
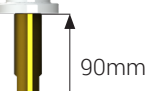
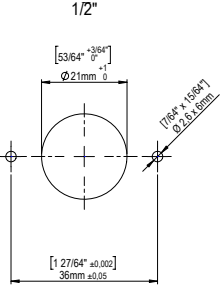
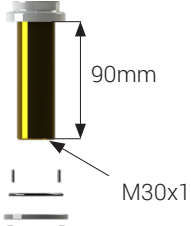
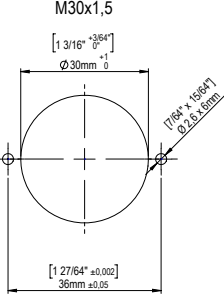

For other configuration options please contact your local BROEN-LAB representative.

ORDERING INFORMATION

Number	Inlet design	Drilling template	Number	Inlet design	Drilling template
-05	 <p>30mm</p> <p>1/2" ISO 7/1R - BROEN-LAB UniFlex™</p>	 <p>1/2"</p> <p>$[53/64^{+0.002}]$ $\phi 21\text{mm}$</p> <p>$[17/64^{+0.002}]$ $\phi 2.5 \times 36\text{mm}$</p> <p>$[127/64^{+0.002}]$ 36mm ± 0.05</p>	-50	 <p>M30x1.5</p>	 <p>M30x1,5</p> <p>$[13/16^{+0.002}]$ $\phi 30\text{mm}$</p> <p>$[127/64^{+0.002}]$ 36mm ± 0.05</p> <p>$[17/64^{+0.002}]$ $\phi 2.5 \times 36\text{mm}$</p>
-14	 <p>60mm</p> <p>1/2" ISO 7/1R - BROEN-LAB UniFlex™</p>	 <p>1/2"</p> <p>$[53/64^{+0.002}]$ $\phi 21\text{mm}$</p> <p>$[17/64^{+0.002}]$ $\phi 2.5 \times 36\text{mm}$</p> <p>$[127/64^{+0.002}]$ 36mm ± 0.05</p>	-52	 <p>30mm 60mm</p> <p>M30x1.5</p>	 <p>M30x1,5</p> <p>$[13/16^{+0.002}]$ $\phi 30\text{mm}$</p> <p>$[127/64^{+0.002}]$ 36mm ± 0.05</p> <p>$[17/64^{+0.002}]$ $\phi 2.5 \times 36\text{mm}$</p>
-18	 <p>90mm</p> <p>1/2" ISO 7/1R - BROEN-LAB UniFlex™</p>	 <p>1/2"</p> <p>$[53/64^{+0.002}]$ $\phi 21\text{mm}$</p> <p>$[17/64^{+0.002}]$ $\phi 2.5 \times 36\text{mm}$</p> <p>$[127/64^{+0.002}]$ 36mm ± 0.05</p>	-54	 <p>90mm</p> <p>M30x1.5</p>	 <p>M30x1,5</p> <p>$[13/16^{+0.002}]$ $\phi 30\text{mm}$</p> <p>$[127/64^{+0.002}]$ 36mm ± 0.05</p> <p>$[17/64^{+0.002}]$ $\phi 2.5 \times 36\text{mm}$</p>

 <p>Standard length 700mm</p>	 <p>Standard length 310mm</p>	 <p>Standard length 700mm</p>	 <p>Standard length 700mm</p>
No pipe No code	OD 10 mm Code "B"	CU-pipes Code "C"	G 1/2" Union nut Code "E"
			OD 15 mm Code "H"

For installation with Cu- and Stainless Steel BROEN-LAB offers a wide range of connection fittings and adapters for pipes of different dimensions.

Please request document No. 99G0004 for a complete range of BROEN-LAB UniFlex™ compression ring fittings.

HEADQUARTER

BROEN-LAB A/S

Drejervaenget 2
5610 Assens
Denmark

Tel. +45 6376 6376
Fax +45 6471 2476

lab@broen-lab.com
broen-lab.com

INTERNATIONAL OFFICES

BROEN-LAB Ltd.

Tel. +44 121 522 4515

lab@broen-lab.com
broen-lab.com

BROEN-LAB Singapore Pte. Ltd.

25 International Business Park
#04-60A German Centre
Singapore 609916

Tel. +65 6298 0662

lab@broen-lab.com
broen-lab.com

BROEN-LAB GmbH

Tel. +45 6376 6376

lab@broen-lab.com
broen-lab.com

BROEN-LAB Sverige AB

Tel. +45 6376 6376

lab@broen-lab.com
broen-lab.com

BROEN-LAB Inc.

15 Constitution Drive
Suite 122
NH 03110
Bedford
USA

Tel. +1 603 310 5089

lab@broen-lab.com
broen-lab.com

BROEN-LAB develops, manufactures and sells Laboratory Fittings, Emergency Shower Systems and Eye Wash Systems into a broad spectrum of laboratories and industrial locations; sectors include Pharmaceutical, Food&Beverage and Academia. Our expertise and product quality ensure optimal solutions compliant to all relevant international norms setting new standards in risk mitigation in modern research and development facilities.

BROEN-LAB offers solutions that ensure the functionality, compliance, hygiene, durability and safety are of the highest priority. For more than 50 years our products have been integrated into a wide variety of workplaces, laboratories, hospitals and industrial locations, with features that are assessed and designed to be flexible, durable and compliant offering a broad range of options tailored to each location. This inherent design integrity provides confidence in the solution adopted wherever in the world these are applied.

BROEN-LAB is a collaboration partner in the design and layout of your next laboratory and it's integrated safety.



BROEN-LAB A/S ISO 9001 certification

In September 1991 BROEN-LAB A/S was certified according to ISO 9001 as one of the first Danish companies. The certification was carried out by Bureau Veritas, Denmark, for our Danish site in Assens.

The quality management system of BROEN-LAB A/S now complies with detailed specifications laid down by the internationally acknowledged EN ISO 9001:2015. This certification will further contribute to reputation for quality and reliability of BROEN-LAB A/S.

BROEN-LAB A/S ISO 14001:2015 certification

In December 2022 we got certified according to ISO 14001 in Environmental certification. The new certification was carried out by Bureau Veritas, Denmark, for Danish site in Assens. The Environment ISO14001 management system of BROEN-LAB A/S is included in internationally acknowledged EN ISO 9001:2015. Both certifications furthermore contribute to reputation for quality and reliability of BROEN-LAB A/S.